



EMV-200 video Gastroscope and EMV-400 video Colonoscope

Option 1 :---Standard option

	Item	video Gastroscope	video Colonoscope
	Diameter of distal- end	Φ9.4mm	Φ13.0mm
	Diameter of insert tube	Φ9.3mm	Φ12.8mm
	Clamp aperture	Φ2.8mm	Φ 3.8mm
	Working length	1100 mm	1690mm
	Total length	1400 mm	1990mm
	View of field	140 °	140 °
	Depth of view	3-100mm	3-100mm
	Resolution	Sony 440,000 Pixels high resolution Photosensitive1/6 CCD	
	Tip deflection	up 210°down 90°L/R 100°	up 180°down 180°L/R 160°
Remark	We can provide OEM service, technical details can be customized.		

Option 2:---HD option

	Item	video Gastroscope	video Colonoscope
	Diameter of distal- end	Φ9.4mm	Φ13.0mm
	Diameter of insert tube	Φ9.3mm	Φ12.8mm
	Clamp aperture	Φ2.8mm	Φ 3.8mm
	Working length	1100 mm	1690mm
	Total length	1400 mm	1990mm
	View of field	140 °	140 °
	Depth of view	3-100mm	3-100mm
	Resolution	Sony 480,000 Pixels high resolution Photosensitive1/6 CCD	
	Tip deflection	up 210°down 90°L/R 100°	up 180°down 180°L/R 160°
Remark	We can provide OEM service, technical details can be customized.		

Characters:

Part 1: EMV-200 video Gastroscope and EMV-400 video colonoscope

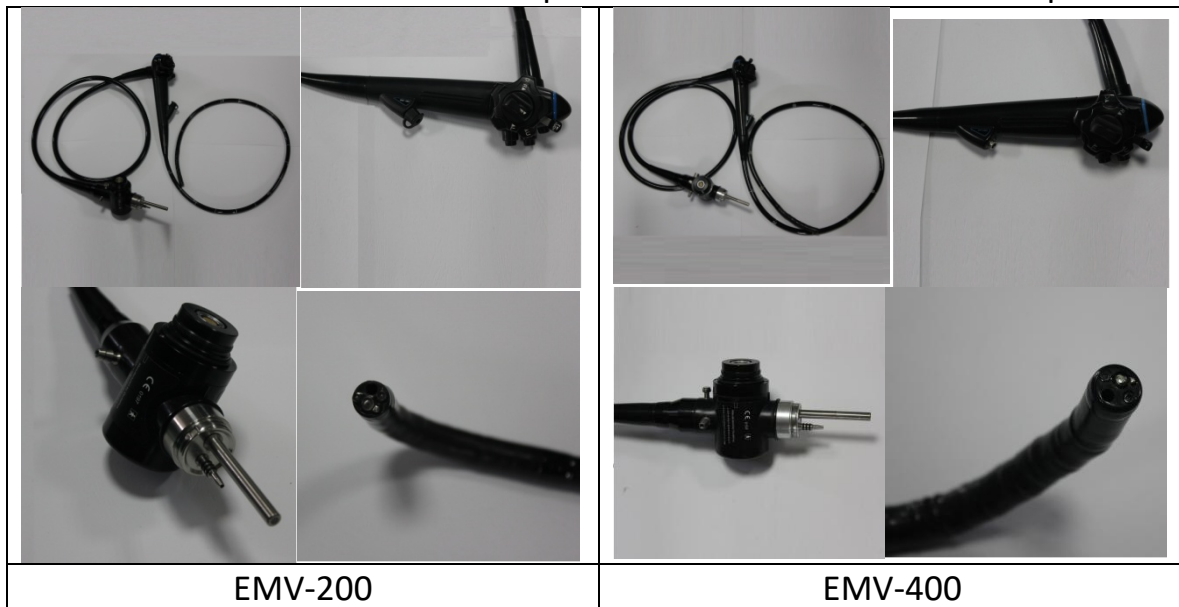

Bending operation : Traction chain structure, whole sealed waterproof

Image display : Two image display optional



Split machine : Main part and light source are splitted

Quality certification : ISO9001, 13485, CE

Warranty : One year(free), permanent repairs (not free)



Package size :64*18*48cm (G.W.:5.18kgs)

Part 2: Video processor and light cold source machine EMV-3000

Option 1 :---Standard option	Option 2:---HD option
	
Lamp : LED light (80W white)	Lamp : LED light (80W white)
Power: 220-240V; 50-60HZ	Power: 220-240V; 50-60HZ
Illuminance : ≥200,000 lx	Illuminance : ≥200,000 lx
Color temperature : ≥5300K	Color temperature : ≥5300K
Video signal output: 2 CVBS,S-Video	Video signal output: CVBS , S-VIDEO , RGB , DVI
Sharpness adjustment :0-30 grade	Sharpness adjustment :0-30 grade
White balance : Auto white balance/ Manually white balance	Brightness adjustment : 0-10 grade

Gain function : 1-3 grade	Color setting : Red , Blue (0-128 grade)
Electronic shutter :Auto-shutter ,Manual shutter 10 steps can be adjustment.	White balance : Auto white balance/ Manually white balance
Air pump pressure : 30-60Mpk,	Gain function : 1-5 grade
Metering mode :Peck metering / average metering, metering Area delineation	Air pump pressure : 30-60Mpk, Air flow : 4-10 L/min
Lens optional :Manual lens, automatic lens, video lens , Left and right side Image position transformation	Image mode : Horizontal / Vertical image
Air flow : 4-10 L/min	Metering mode : Peck metering / average metering
Package size :50.5*46*20cm (G.W.:7.34kgs)	Image enhancement : 1-4 grade
Main Function: DSP -digital image processor ,color ,brightness,Contrast 0-100 grade can be adjustment . Continuous 4 pcs Image frozen and playback function (no power no stored). Black and white reverse function . Digital widescreen and picture in picture function.	Main Function: Support vascular enhancement function . 16 pcs Image frozen and playback and images can be saved in SD card directly. Personalized parameter storage and adjustment function.
Remark : this machine support Rigid endoscopy connection	

Part 3: LCD Monitor

Item	Option 1	Option 2
Picture		
Display size	15"	19"
Power Supply	External Power Supply 12V	External Power Supply 12V
Resolution	1024X768	1280x1024
Display Ratio	4:3	5:4
Color	16.7M	16.7M
Camoration Brightness	180 ± 10 cd/m ²	180 ± 10 cd/m ²
Max.Brightness	400 cd/m ²	400 cd/m ²
Package size	44*36.5*16.5cm (G.W.:6.0kgs)	44*36.5*16.5cm (G.W.:6.0kgs)

Part 5: Equipment vehicles

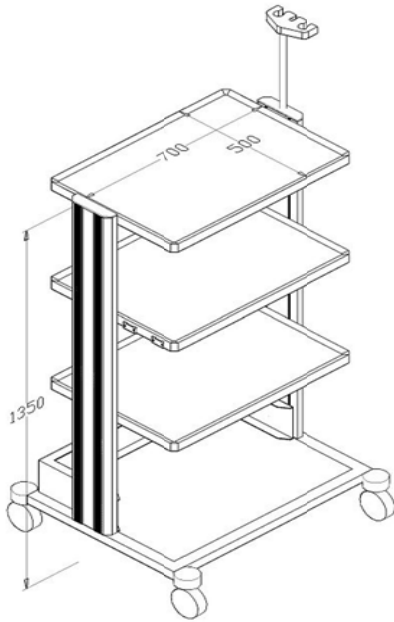

Size : 500 * 700 *1350mm

Package size:118.5*63.5*22cm (G.W.:44.5kgs)

Option 1 :---Standard option

- 1pc video gastroscope
- +1pc video colonoscope
- +1pc video center(Green)
- + 1pc 15" LCD monitor
- + 1 set trolley
- + 1set section device

option 2 :---HD option

- 1pc video gastroscope
- +1pc video colonoscope
- +1pc video center (Grey)with 16GB record card
- + 1pc 19" LCD monitor
- + 1 set trolley
- + 1set section device